

# Zyla<sub>sCMOS</sub>

## Speed and Sensitivity for Physical Science Imaging and Spectroscopy

### ZYLA 4.2 PLUS

- 4.2 megapixel sCMOS
- 82% peak QE
- 0.9 e<sup>-</sup> read noise
- 100 fps (53 fps USB 3.0)
- 33,000:1 dynamic range

### ZYLA 5.5

- 5.5 megapixel sCMOS
- Rolling & True Global Shutter
- 0.9 e<sup>-</sup> read noise
- 100 fps (40 fps USB 3.0)
- 33,000:1 dynamic range

- ✓ **NEW** On-head spectroscopy and multi-track processing
- ✓ QE boosted to 82%
- ✓ >99.8 % Quantitative Linearity

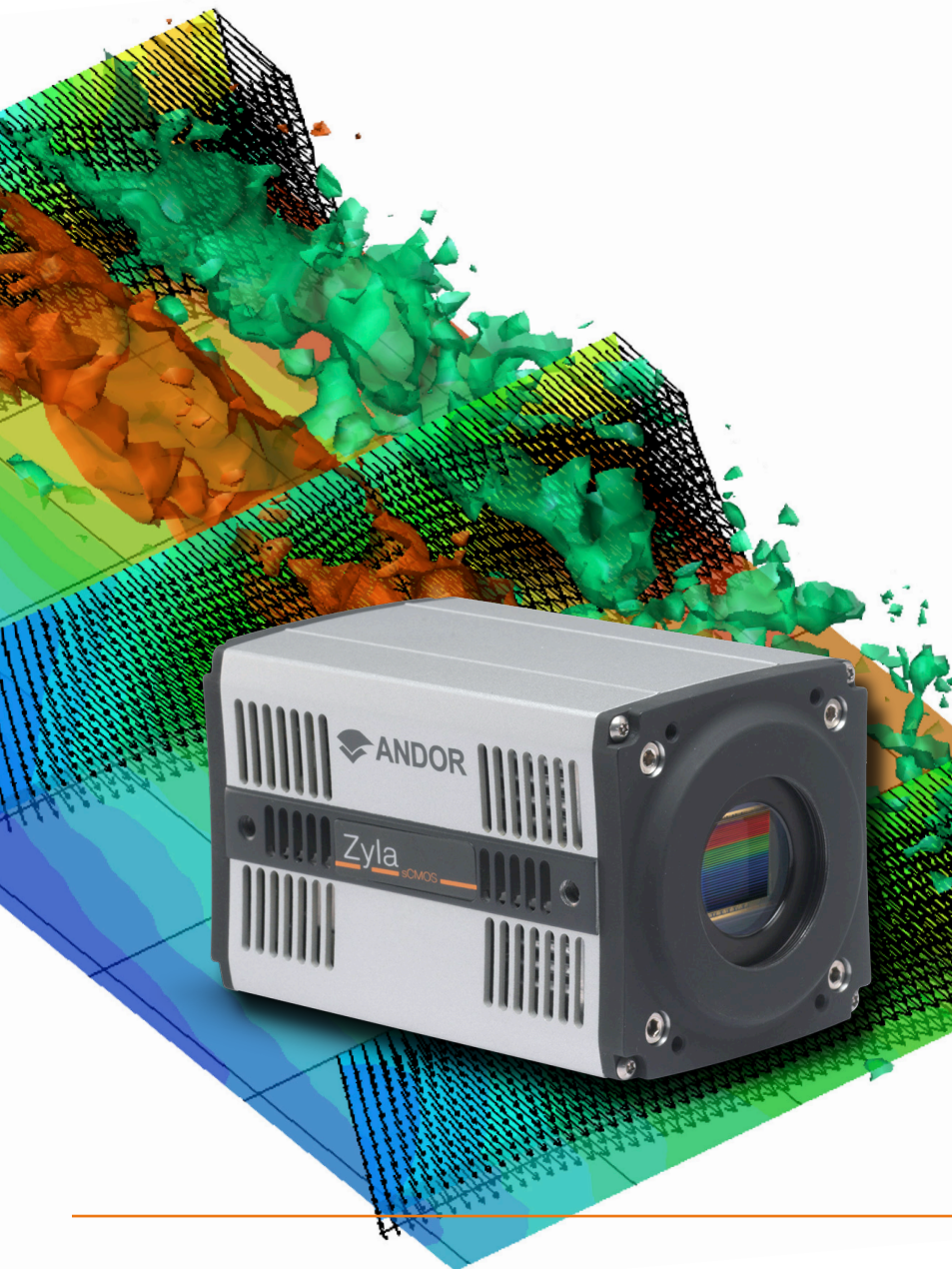

# Features & Benefits



Andor's Zyla sCMOS camera platform offers high speed, high sensitivity and high resolution imaging and spectroscopy performance. The remarkably light and compact, thermoelectrically cooled design, integrates perfectly into both laboratory and OEM applications alike. Zyla is ideally suited to many cutting edge experiments that push the boundaries of speed and sensitivity.

## Feature

## Benefit

<b>5.5 &amp; 4.2 megapixel sensor formats and 6.5 <math>\mu\text{m}</math> pixels</b>	Extremely sharp resolution over a 22 mm (Zyla 5.5) and 19 mm (Zyla 4.2 PLUS) diagonal field of view. Ideal for astronomy, area scanning applications or multi-track spectroscopy.
<b><math>\sim 1 e^-</math> Read Noise</b>	Noise floor down to $0.9e^-$ . Lower detection limit than any CCD.
<b>100 fps (Camera Link)</b>	Zyla offers '10-tap' Camera Link for maximum sustained frame rates. (Burst to 4GB on-head memory on Neo).
<b>Up to 27,000 fps ('FCS' mode) or sps</b>	Excellent time resolution capabilities for study of transient phenomena through user-definable Region of Interest control.
<b>Rolling and Global shutter (Zyla 5.5)</b>	Maximum exposure and readout flexibility across all applications. Global Shutter for 'interline CCD mode' freeze frame capture of fast moving/changing events.
<b>12-bit and 16-bit modes</b>	12-bit mode for smaller file size and absolute fastest frame rates through USB 3.0; 16-bit mode for full dynamic range.
<b>Market leading USB 3.0 speed</b>	Superb USB 3.0 data transfer efficiency and Zyla's unique 12-bit high speed mode deliver up to 53 fps full resolution, 77% faster than competing sCMOS. Follow dynamic processes with improved temporal resolution.
<b>Extended Dynamic Range</b>	Unique 'dual gain amplifier' sensor architecture offering dynamic range of 33,000:1.
<b>NEW QE<sub>max</sub> boosted to 82%</b>	Highest available photon capture efficiency across visible/NIR.
<b>ZERO etaloning in the NIR</b>	Front-illuminated sensor architecture, no unwanted signal modulation in the NIR compared to back-illuminated devices.
<b>Better than 99.8% linearity</b>	Unparalleled quantitative measurement accuracy across the full dynamic range (> 99.9% for low light range).
<b>PIV mode inter-frame down to 100 ns</b>	sCMOS sensor architecture allows rapid image pair acquisition with optical transition time between images down to 100 ns, well suited to a wide range of Particle Image Velocimetry (PIV) applications.
<b>Dynamic Baseline Clamp</b>	Ensure quantitative stability.
<b>Dark Noise Suppression (DNS) technology</b>	Extremely competitive low dark current of $0.10 e^-/\text{pix}/\text{sec}$ with fan cooling. Maintains low noise advantage across range of exposure conditions.
<b>TE cooling to <math>0^\circ\text{C}</math> in up to <math>30^\circ\text{C}</math> ambient</b>	Ideal for OEM integration into enclosed systems.
<b>NEW GPU Express</b>	Simplify and optimize data transfers from camera to Graphical Processing Unit (GPU) card to facilitate accelerated GPU processing as part of the acquisition pipeline.
<b>Very Low Fan Vibration</b>	Implemented on both models. Designed with vibration sensitive experiments in mind.
<b>Hardware Timestamp</b>	FPGA generated timestamp with 25 ns accuracy.
<b>Compact and Light</b>	Ideal for integration into space restrictive set-ups. Ideal for OEM.

## NEW Spectroscopy Modes (option)

<b>On-head asymmetric binning and multi-track</b>	On-board intelligence delivering Spectroscopists-friendly spectra and multi-track data prior to transfer through 10-tap or USB interface. Upfront data size reduction and easier user data processing.
<b>Selectable bit-depth up to 32-bit</b>	Preserve dynamic range in extensive on-head binning scenarios. User-selectable data bit depth to be transmitted over the camera interface, up to 32-bit.

# Zyla

## THE PHYSICIST'S CHOICE

Zyla sCMOS has become a well established detector amongst physicists, biophysicists and astronomers, the advanced combination of speed, sensitivity and dynamic range enabling new ground to be broken.

### Performance & Adaptability

- **Dual Amplifier** – novel pixel architecture means you don't need to pre-select gain. Access lowest read noise and full well depth simultaneously.
- **1000 fps** – Access extremely fast frame rates through user definable Region of Interest control, suited to many applications within the physical sciences.
- **GPU Express** – for real time processing.
- **Global Shutter** – Zyla 5.5 offers this important mode that completely avoids spatial distortion, and ensures temporal correlation across all regions of the sensor. Achieve sub-microsecond inter-frame gaps in PIV applications.
- **Low darkcurrent** – low read noise is complimented by extremely competitive darkcurrent, also ensuring minimized hot pixel blemishes.
- **Cooling options** – standard Zyla 5.5 camera air cools to 0°C at up to +30°C ambient. Water cooled option available on request.
- **Blemish correction maps and advanced control** Andor provide the capability to turn off/on blemish correction for those who prefer to perform this themselves. Bespoke blemish maps can also be provided.
- **Compact and Light** – the extremely small volume footprint of Zyla renders it adaptable to intricate optical set-ups.

### Example Areas of Application

#### Particle Imaging Velocimetry (PIV)

The true Global Shutter mode of Zyla 5.5 facilitates an inter-frame gap of down to 100 ns.

#### Lucky / Speckle Imaging

Zyla's fast frame rate and large field of view are ideal for this resolution enhancing technique. **GPU Express** for real time data processing.

#### Solar Astronomy

Fast frame rates, wide dynamic range and great linearity present a very formidable solution to the specific detector needs of next generation large solar telescopes.

#### Bose Einstein Condensation

The QE profile of Zyla is very good in the red/NIR region, ideal for BEC of Rb.

#### Adaptive Optics

Accessing > 1000 fps using ROIs renders the Zyla an ideal Wavefront detector. Use with data splitter to enable direct data access.

#### Fluorescence Correlation Spectroscopy

Superb temporal resolution from small ROIs are excellent for accurately measuring diffusion coefficients.

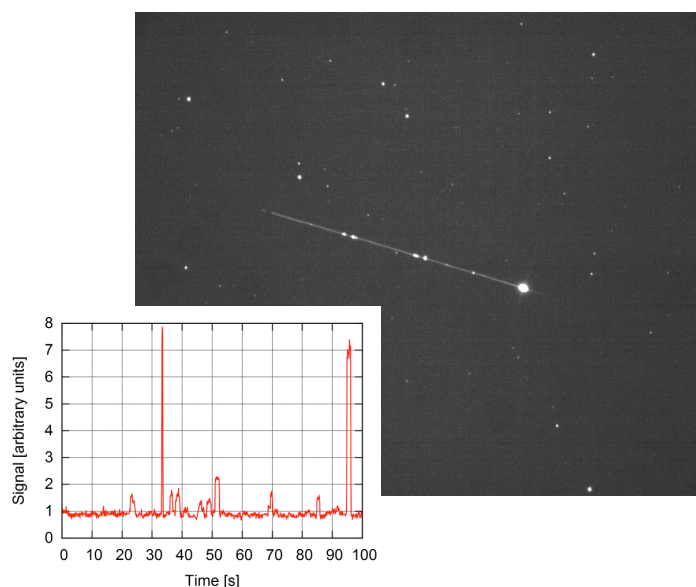

Zyla 5.5 operating at 10 Hz, detecting a Russian rocket upper stage - image and corresponding light curve shown. *Institute of Technical Physics Deutsches Zentrum für Luft- und Raumfahrt (DLR) - German Aerospace Center, Stuttgart, Germany.*

### Spectroscopy Modes (option)

- **On-head asymmetric binning & multi-track**  
Intelligent data processing from the sensor into Spectroscopy-friendly spectra or multi-channel data format, ahead of transfer through the 10-tap or USB interface; greatly reduces data post-processing and data set size at the user side.
- **User-definable bit depth**  
Up to 32-bit data packaging option to overcome the limitation of the standard 16-bits data transfer through 10-tap or USB3 in extensive binning scenarios.

#### Hyperspectral Imaging & multi-track spectroscopy

On-head FPGA functions can discriminate up to 256 individual channels (e.g. multi-leg fibre optic) with no acquisition rate sacrifice compared to CCDs. Takes great advantage of Andor's spectrograph portfolio imaging portfolio e.g. Andor HoloSpec.

#### Transient spectroscopy

Samples highly dynamic chemical reactions or phenomena with spectral rates up to 27,000 sps with 10-tap Zyla 5.5 and 26,000 sps with 10-tap Zyla 4.2.



# Rolling & Global Shutter

The **Zyla 5.5** uniquely offers both Rolling and *true* Global Shutter exposure modes. This provides superior application and synchronization flexibility and the ability, through global exposure, to closely emulate the familiar ‘Snapshot’ exposure mechanism of interline CCDs.

## Key Benefits of *True* Global Exposure

- **NO Spatial Distortion** – avoiding the spatial distortion risk of rolling exposure
- Tight syncing to **peripheral switching devices**
- **Higher Signal to Noise** due to **reduced dead time** – the entire exposure cycle can be used
- **Simplicity** – all the benefits of an ‘interline exposure mode’
- **Continuous or Pulsed** light sources
- **100 ns inter-frame gaps in PIV applications**

## ‘Simulated’ Global Exposure in Zyla 4.2 PLUS

[Click here](#) to read more about this mode and other Frequently Asked Questions on Rolling and Global Exposure modes.

## Rolling & Global Shutter Mechanisms

Rolling and *true* Global Shutter modes describe two distinct types of exposure and readout sequence.

In rolling shutter, available in Zyla 4.2 PLUS and Zyla 5.5, different lines of the array are exposed at different times as the read out ‘wave’ sweeps through the sensor. 10 ms is required at the start to ‘activate’ the sensor to expose, and then 10 ms is required at the end to readout the sensor. Use when not synchronizing to peripheral devices AND only when there is a minimal risk of spatial distortion from moving samples.

In *true* global shutter, available in Zyla 5.5, each pixel in the sensor begins the exposure simultaneously and ends the exposure simultaneously. This provides a true ‘Snapshot’ exposure capability for moving samples that is both ‘photon-efficient’ and easy to synchronize to. Zyla 4.2 PLUS, while utilizing a rolling shutter sensor, offers a *Simulated* Global Exposure mechanism to overcome risk of spatial distortion. This mechanism is more elaborate and less photon/time efficient than *true* Global Shutter.

[Click here](#) to read more about Rolling and Global shutter modes on our Zyla camera.

### Global Shutter exposure and readout (single scan)



Exposure Start

Exposure

Exposure End

### Rolling Shutter exposure and readout (single scan)



Exposure Start

Exposure

Readout

For further information of Rolling and Global Shutter, please access the following technical notes through the Andor Learning Centre: 1) Rolling and Global Shutter 2) Synchronizing to Rolling and Global Shutter sCMOS cameras

## GPU Express



The Andor GPU Express library has been created to simplify and optimize data transfers from camera to a CUDA-enabled NVidia Graphical Processing Unit (GPU) card to facilitate accelerated GPU processing as part of the acquisition pipeline. GPU Express integrates easily with SDK3 for Windows, providing a user-friendly but powerful solution for management of high bandwidth data flow challenges; ideal for data intensive applications such as tomography, 3D PIV or Adaptive Optics.

- Enhanced convenience, afforded by simple, optimized GPU data management
- Optimal data throughput
- Superb, easily accessible documentation and examples

# Meet the Extended sCMOS Family for Physical Sciences

## Zyla sCMOS

For physical imaging, astronomy and spectroscopy



- ✓ Particle Image Velocimetry (PIV)
- ✓ Lucky/Speckle imaging
- ✓ Solar astronomy
- ✓ Bose Einstein Condensation (BEC)
- ✓ Adaptive Optics (AO)
- ✓ Fluorescence Correlation Spectroscopy (FCS)

## iStar sCMOS

For nanosecond gated imaging and spectroscopy



- ✓ Quantum physics
- ✓ Plasma diagnostics
- ✓ Flow/Spray/Combustion processes study
- ✓ Planar Laser-Induced Fluorescence (PLIF)
- ✓ Time-resolved luminescence

## Zyla-HF

For indirect x-ray imaging



- ✓ Hard x-ray imaging and spectroscopy
- ✓ High Harmonic Generation (HHG)
- ✓ X-ray plasma spectroscopy
- ✓ X-ray tomography
- ✓ Transmission Electron Microscopy (TEM)

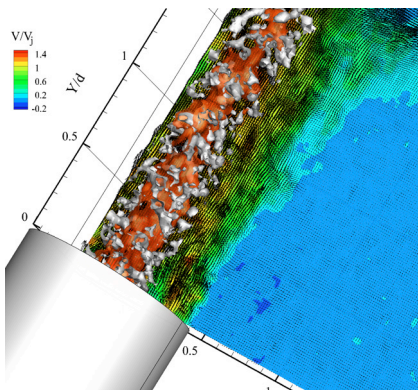

3D flow field study by PIV (using 4x Zyla), courtesy of *Gioacchino Cafiero, Universit' a di Napoli Federico II.*

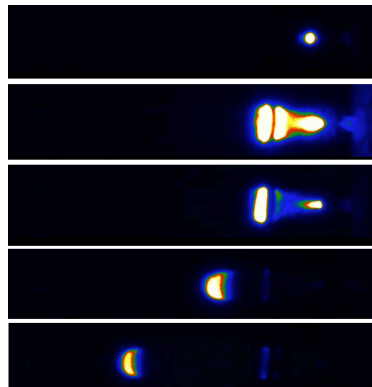

Plasma bullet time-dynamics studies, courtesy of *Jérôme Bredin at York Plasma Institute.*

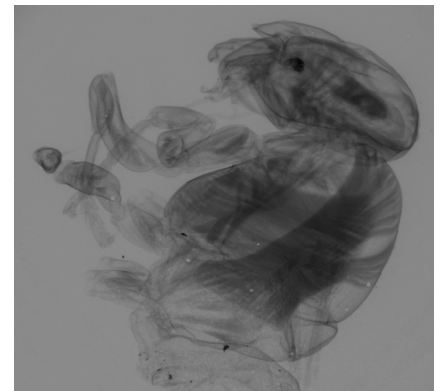

X-Ray absorption image of a wasp taken with a 40 kV X-ray source, courtesy of *Crytur.*



For more information on the iStar sCMOS:

<http://www.andor.com/cameras/istar-intensified-scmos-and-iccd>



For more information on the Zyla-HF:

<http://www.andor.com/scientific-cameras/high-energy-detection/zyla-scmos-hf>

# Technical Data

## Model Specific Specifications<sup>\*1</sup>

Model	Zyla 5.5	Zyla 4.2 PLUS		
Sensor type	Front Illuminated Scientific CMOS	Front Illuminated Scientific CMOS		
Active pixels (W x H)	2560 x 2160 (5.5 Megapixel)	2048 x 2048 (4.2 Megapixel)		
Sensor size	16.6 x 14.0 mm 21.8 mm diagonal	13.3 x 13.3 mm 18.8 mm diagonal	6.5 µm / px	
Pixel readout rate (MHz)	200 (100 MHz x 2 sensor halves) 560 (280 MHz x 2 sensor halves)	Slow Read 216 (108 MHz x 2 sensor halves) Fast Read 540 (270 MHz x 2 sensor halves)		
Read noise (e <sup>-</sup> ) Median [rms] <sup>*2</sup>				
		<b>Rolling Shutter</b>	<b>Global Shutter</b>	<b>Rolling Shutter</b>
	@ 200 MHz	0.9 [1.2]	2.3 [2.5]	@ 216 MHz
	@ 560 MHz	1.2 [1.6]	2.4 [2.6]	@ 540 MHz
Maximum Quantum Efficiency <sup>*3</sup>	60%			82%
Sensor Operating Temperature				
Air cooled	0°C (up to 30°C ambient)			0°C (up to 27°C ambient)
Water cooled	-10°C*			-10°C*
Dark current, e <sup>-</sup> /pixel/sec @ min temp <sup>*4</sup>				
Air cooled	0.10			0.10
Water cooled	0.019			0.019
Readout modes	Rolling Shutter and True Global Shutter (Snapshot)			Rolling Shutter and Global Clear <sup>*8</sup>
Maximum dynamic range	33,000:1			33,000:1
Photon Response Non-Uniformity (PRNU)				
Half-light range			< 0.01%	
Low light range			< 0.1%	
Pre-defined Region of Interest (ROI)	2048 x 2048, 1920 x 1080, 1392 x 1040, 512 x 512, 128 x 128			1920 x 1080, 1392 x 1040, 512 x 512, 128 x 128
User defined ROI (granularity)				Yes (1 pixel) <sup>**</sup>
Data range				12-bit (fastest USB 3.0 speeds) and 16-bit (maximum dynamic range)
Interface options				USB 3.0 <sup>*9</sup> Camera Link 10-tap

\* Cooling temperature must be above the dew point

\*\* Minimum ROI size: 4 x 8 (W x H) possible for 12- or 16-bit modes and for both Camera Link 10-tap and USB 3.0 models

## General Specifications<sup>\*1</sup>

Pixel size (W x H)	6.5 µm
Pixel well depth (e <sup>-</sup> )	30,000
Linearity (% maximum) <sup>*5</sup>	
Full light range	Better than 99.8%
Low light range (< 1000 electrons signal)	Better than 99.9%
MTF (Nyquist @ 555 nm)	45%
Pixel binning	Hardware binning: 2 x 2, 3 x 3, 4 x 4, 8 x 8
Anti-blooming factor	x 10,000
I/O	External Trigger, Fire, Fire n, Fire All, Fire Any, Arm
Trigger Modes	Internal, External, External Start, External Exposure, Software Trigger
Software Exposure Events <sup>*6</sup>	Start exposure - End exposure (row 1), Start exposure - End exposure (row n)
Hardware timestamp accuracy	25 ns
Internal memory	1 GB

## I Imaging Mode

### Frame Rate Table - 12-bit (16-bit)<sup>\*7</sup>

Array Size (W x H)	Zyla 5.5 USB 3.0		Zyla 5.5 10-tap		Zyla 4.2 PLUS 10-tap	Zyla 4.2 PLUS USB 3.0
	Rolling Shutter	Global Shutter	Rolling Shutter	Global Shutter	Rolling Shutter	Rolling Shutter
2560 x 2160	40 (30)	40 (30)	100 (75)	49 (49)	-	-
2048 x 2048	53 (40)	52 (39)	105 (98)	52 (52)	101 (101)	53 (40)
1920 x 1080	107 (80)	98 (80)	200 (200)	97 (97)	192 (192)	107 (80)
512 x 512	422 (422)	201 (201)	422 (422)	201 (201)	406 (406)	406 (406)
128 x 128	1691 (1691)	716 (716)	1691 (1691)	716 (716)	1627 (1627)	1627 (1627)
2048 x 8 (FCS mode)	13020 (10250)	4008 (4008)	27057 (27057)	4008 (4008)	26041 (26041)	13020 (10250)
1024 x 8 (FCS mode)	27057 (27057)	4008 (4008)	27057 (27057)	4008 (4008)	26041 (26041)	26041 (26041)

## S Spectroscopy Mode

### Vertically binned tracks 12-bit & 16-bit<sup>\*7</sup>

Array Size (W x H)	Zyla 5.5 10 tap / USB 3.0		Zyla 4.2 PLUS 10 tap / USB 3.0
	Rolling Shutter*	Global Shutter**	Rolling Shutter*
any x 8	27,057	4,008	26,041
any x 12	18,038	3,491	17,361
any x 16	13,528	3,092	13,020
any x 31	6,764	2,122	6,510
any x 77	2,705	1,093	2,604
any x 100	2,164	909	2,083
any x 128	1,691	736	1,627
any x 154	1,387	618	1,335
any x 462	466	224	448
any x 512	422	203	406
any x 1040	208	102	200
any x 1080	200	98	192
any x 2048	105	52	101

## M Multi-track Mode

### Vertically binned tracks 12-bit & 16-bit<sup>\*7</sup>

Number of tracks (centred vertically)	Track height (h, pixels)	Tracks separation (d, pixels)	Zyla 5.5 10-tap / USB 3.0		Zyla 4.2 PLUS 10-tap / USB 3.0
			Rolling Shutter*	Global Shutter**	Rolling Shutter*
2	12	12	6,012	1,967	5,787
2	20	20	3,607	1,370	3,472
2	154	77	557	265	536
20	12	12	462	222	445
20	20	20	277	135	267
50	12	12	182	89	175
50	20	20	109	54	105
256	8	0	105	52	101

\* Overlap ON  
\*\* Overlap OFF

## How the sCMOS sensor is used in the different modes

The diagrams below illustrate how the sCMOS sensor array is used for the different modes (in this example for the Zyla 4.2 PLUS).

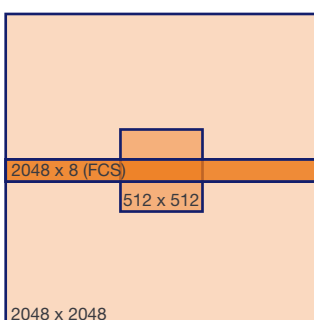

**I Imaging Mode**  
The array size may be defined (includes FCS modes) for either resolution or maximum speed.

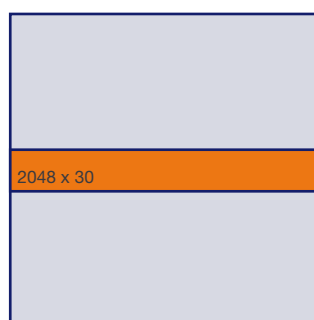

**S Spectroscopy Mode**  
A vertically binned track is centred on the sensor enabling the maximum spectral rate to capture dynamic events.

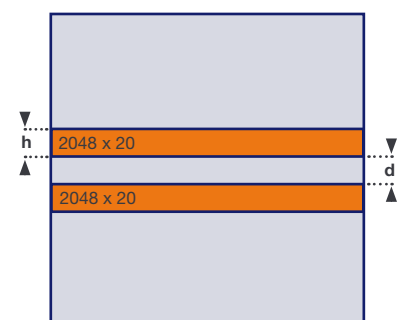

**M Multi-track Mode**  
Up to 256 vertically binned tracks can be used for multi-track analysis without sacrificing speed.

## Quantum Efficiency (QE) Curve <sup>\*3</sup>

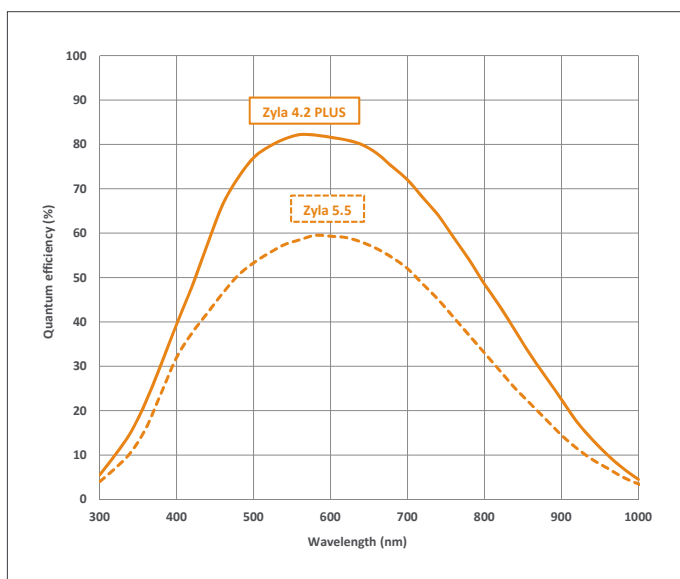

Quantum efficiency curves of the Zyla 4.2 PLUS and Zyla 5.5.

## sCMOS for Spectroscopy and Andor Shamrock Spectrographs

Highly modular motorized platforms with dual output ports, dual/triple grating turrets and a wide range of motorized and field-upgradable accessories.

### Shamrock 750

Delivers the highest spectral resolution of the Shamrock range, down to 0.02 nm.

### Shamrock 500i

Ideal combination of high spectral resolution, imaging capabilities for multi-track acquisitions. Convenient USB interface alongside fully motorized platform and light coupling accessories.

### Shamrock 163

Rugged, compact 163 mm focal length manual spectrograph, highly configurable for general, everyday lab spectroscopy.

### Shamrock 303i

Laboratory workhorse platform with plug and play USB interface, fully motorized triple grating turret, slits and filter wheel and imaging-optimized optics for multi-track spectral acquisition.

### Shamrock 193i

Intelligent, modular and compact imaging spectrograph with Active Focus technology (patented), fully motorized, RFID-tagged dual grating turret, dual detector output ports and seamless interfacing to microscopes for micro-spectroscopy applications.





# sCMOS or EMCCD?

Since the market introduction of sCMOS technology by Andor, the question of the performance comparison against the more established Electron Multiplying CCD (EMCCD) has been common.

Being a very fast, low noise technology, sCMOS does hold some potential to offer an alternative technology to these single photon sensitive detectors across some applications and techniques, including cold atoms imaging or fast spectral chemical mapping.

Whilst the read noise of sCMOS is very low compared to CCDs, EMCCD technology holds the distinct advantage of being able to practically eliminate read noise, rendering them single photon sensitive.

After the first few years of sCMOS being in the market, we are concluding that there are still applications that are benefiting from the ultra-sensitive EMCCD technology, for example quantum optics, photon counting and certain astronomy applications such as Lucky Astronomy and wave front detection.

EMCCDs offer a raw sensitivity that cannot be surpassed in the very low light regime. However, EMCCDs remain relatively expensive, so they will always be considered a more selective, 'high-end' solution.

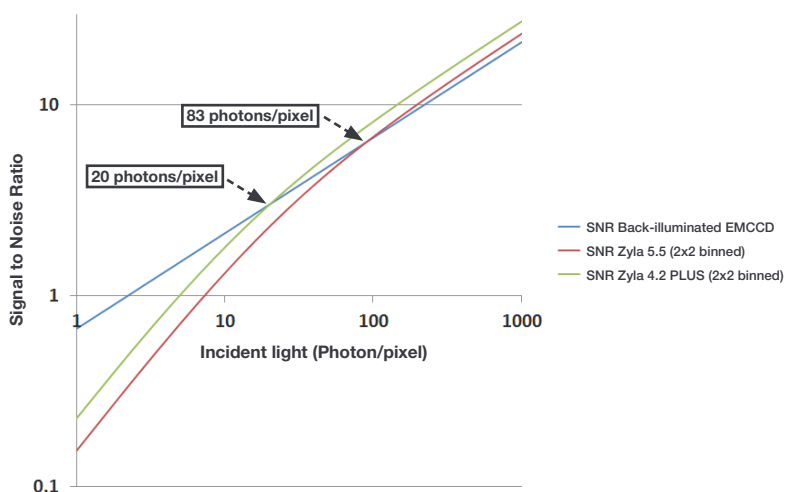

**Figure 1**

Plot of Signal to Noise Ratio versus Incident Photon Intensity, comparing back-illuminated EMCCD iXon 888 (13  $\mu$ m pixel size) to 2x2 binned Zyla sCMOS cameras (13  $\mu$ m pixel size after binning). An average QE value for each sensor between 500-750 nm was used.

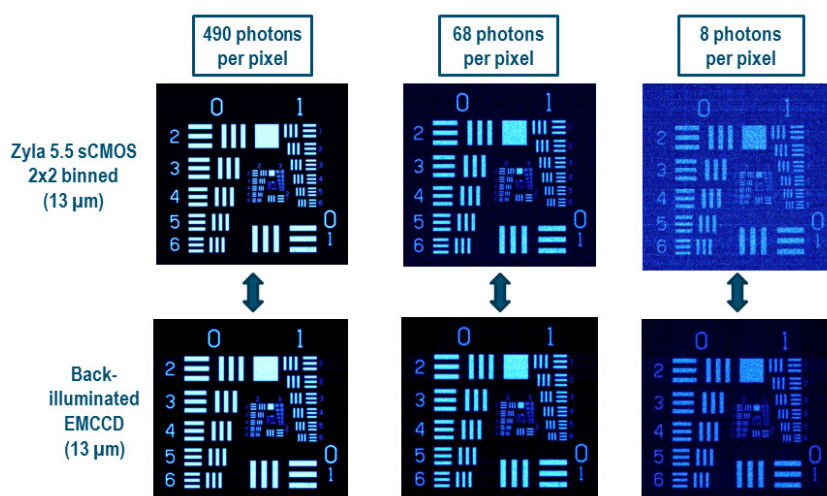

**Figure 2**

Images at a range of incident light intensity, acquired using back-illuminated EMCCD iXon 888 and Zyla 5.5 sCMOS cameras (2x2 binned pixels). At low light intensities, the Signal to Noise Ratio advantage of the EMCCD is apparent.

# Creating the Optimum Product for You

## Step 1. Select the camera type



### Camera Type

Description	Code
ZYLA 4.2 PLUS Spectroscopy, 4.2 Megapixel, Rolling shutter, Camera Link 10-tap	<b>ZYLA-4.2P-CL10</b>
ZYLA 4.2 PLUS Spectroscopy, 4.2 Megapixel, Rolling shutter, USB 3.0	<b>ZYLA-4.2P-USB3</b>
ZYLA 5.5 Spectroscopy, 5.5 Megapixel, Rolling and Global shutter, Camera Link 10-tap	<b>ZYLA-5.5-CL10</b>
ZYLA 5.5 Spectroscopy, 5.5 Megapixel, Rolling and Global shutter, USB 3.0	<b>ZYLA-5.5-USB3</b>

For Spectroscopy mode option, add **-S** to your selected camera codes

For water cooled option, add **-W** to your selected camera code

## Step 2. Select the required accessories

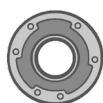

### Accessories

Description	Order Code
CS-mount adapter	<b>ACC-MEC-05609</b>
F-mount adapter	<b>ACM-05574</b>
Auto extension tubes (set of 3) for C-mount	<b>OA-ECMT</b>
Auto extension tubes (set of 3) for Nikon F	<b>OA-ENAF</b>
Re-circulator for enhanced cooling performance	<b>XW-RECR</b>
Oasis 160 Ultra compact chiller unit	<b>ACC-XW-CHIL-160</b>
7-way Multi I/O timing cable, offering Fire, External Trigger, Shutter and Arm. 3 meter.	<b>ACC-ACZ-05612</b>
5 meter Camera Link connector cable. Order x2 if using with Zyla Camera Link 10-tap models.	<b>ACC-ASE-02992</b>
10 meter active Camera Link connector cable, including power supply. For use with Zyla 10-tap Camera Link models.	<b>ACC-ASE-06962</b>
30 meter fibre-optic extender solution for use with Zyla Camera Link 10-tap models.	<b>ACC-ZYLFOX-10TAP-30M</b>
100 meter fibre-optic extender solution for use with Zyla Camera Link 10-tap models.	<b>ACC-ZYLFOX-10TAP-100</b>
15 meter active USB 3.0 connector cable (power supply not required). For use with Zyla USB 3.0 models.	<b>ACC-ASE-06887</b>
50 meter fibre optic USB 3.0 extender solution including power supply. For use with Zyla USB 3.0 models.	<b>ACC-ASE-08762</b>
100 meter fibre optic USB 3.0 extender solution including power supply. For use with Zyla USB 3.0 models.	<b>ACC-ASE-07860</b>
PC Workstation for up to 100 fps continuous spooling to hard drives, acquiring up to 120,000 12-bit full resolution images: Dell T7910XL, 2.6 GHz Eight Core, 8 GB RAM, 4 x 250GB SSD hard drive configured in RAID 0.	<b>WKST-1 WIN</b>
PC Workstation for up to 100 fps continuous spooling to RAM, acquiring up to 6,000 12-bit full resolution images: Dell T5810, 3.5 GHz Quad Core, 64 GB RAM.	<b>WKST-3 WIN</b>

For further information on PC workstations for Zyla, please refer to the technical note [PC Specifications for sCMOS](#)

## Step 3. Select the required software



### Software

The Zyla also requires at least one of the following software options:

**Solis Spectroscopy** A 32-bit and fully 64-bit enabled application for Windows (7, 8, 8.1 and 10) offering rich functionality for data acquisition and processing. AndorBasic provides macro language control of data acquisition, processing, display and export.

**Andor SDK3** A software development kit that allows you to control the Andor sCMOS cameras from your own application. Available as 32 and 64-bit libraries for Windows (7, 8, 8.1 and 10) and Linux. Compatible with C/C++, LabView and Matlab.

**GPU Express** Andor GPU Express library has been created to simplify and optimize data transfers from camera to a CUDA-enabled NVidia Graphical Processing Unit (GPU) card to facilitate accelerated GPU processing as part of the acquisition pipeline. Integrates easily with Andor SDK3 for Windows.

#### Third party software compatibility

Drivers are available so that the Zyla can be operated through a large variety of third party software packages. See Andor web site for detail: <http://www.andor.com/scientific-software>

# Product Drawings

Dimensions in mm [inches]

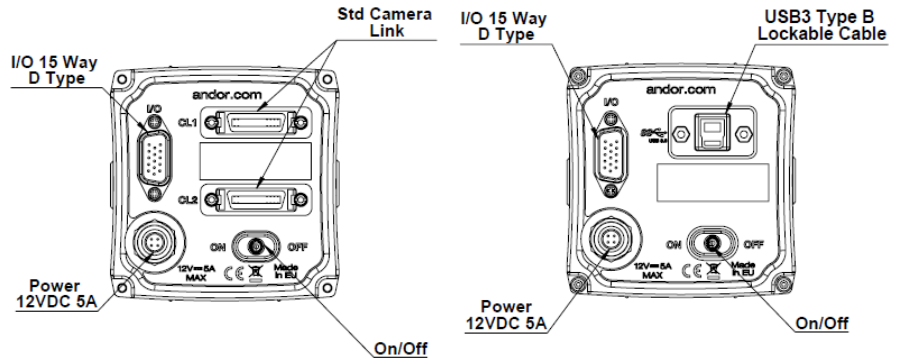
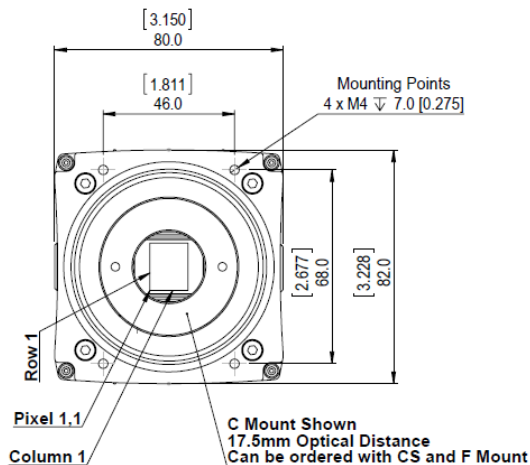
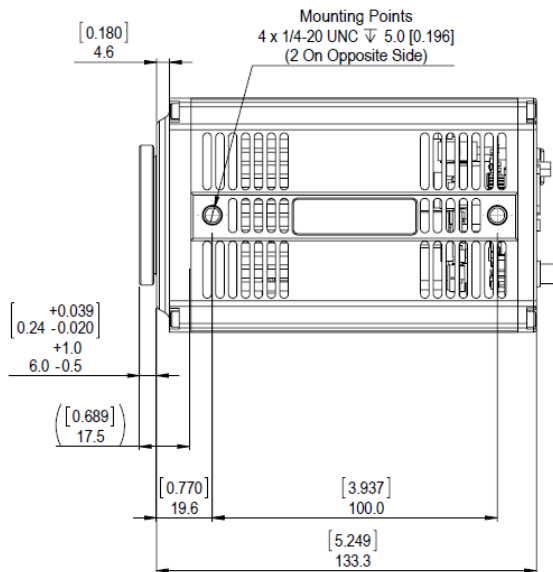
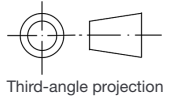

Weight: 1,000 g [2 lbs 3 oz]

Product drawings of the water cooled Zyla can be found at <http://www.andor.com/watercooledzyla>

## CONNECTING TO THE ZYLA

### Camera Control

Connector type: 3 meter Camera Link 10-tap connectors or USB 3.0. (Longer lengths available as accessories).

### TTL / Logic

1 x 3-way Multi I/O timing cable, offering Fire, External Trigger and Arm (1.5 meter)

## REGULATORY COMPLIANCE

- RoHS compliant
- EU EMC Directive
- EU LV Directive
- IEC 61010-1 CB Scheme

## EXTERNAL POWER SUPPLY COMPLIANCE

- UL-certified for Canada and USA
- Japanese PSE Mark

## POWER SUPPLY REQUIREMENTS

- Power: +12 VDC  $\pm$  5% @ 5A
- Ripple: 200 mV peak-peak 0 - 20 MHz
- 100 - 240 VAC 50/60 Hz external power supply
- Power Consumption: 12V @ 5A Max, 12V @ 2.5A Nominal

## 15-WAY D-TYPE PINOUTS

1	ARM	Output
2	Aux_Out_1*	Output
3	FIRE row n	Output
4	FIRE row 1	Output
5	Aux_Out_2	Output
6	Ground	GND
7	External Trigger	Input
8	Spare Input	Input
9	Reserved	N/A
10	Reserved	N/A
11	Reserved	N/A
12	Reserved	N/A
13	Reserved	N/A
14	Reserved	N/A
15	Reserved	N/A

\* Aux\_Out\_1 is configurable as Fire, Fire n, Fire All or Fire Any. Refer to the Zyla hardware manual.



# ORDER TODAY

Need more information? At Andor we are committed to finding the correct solution for you. With a dedicated team of technical advisors, we are able to offer you one-to-one guidance and technical support on all Andor products. For a full listing of our regional sales offices, please see: [andor.com/contact](http://andor.com/contact)

Our regional headquarters are:

#### EUROPE

Belfast, Northern Ireland  
Phone +44 (28) 9023 7126  
Fax +44 (28) 9031 0792

#### JAPAN

Tokyo  
Phone +81 (3) 6732 8968  
Fax +81 (3) 6732 8939

#### NORTH AMERICA

Concord, USA  
Phone +1 (860) 290 9211  
Fax +1 (860) 290 9566

#### CHINA

Beijing  
Phone +86 (10) 8271 9066  
Fax +86 (10) 8271 9055

#### ITEMS SHIPPED WITH YOUR CAMERA

**For Camera Link 10-Tap Models:** 1 x Camera Link Card and 2 x 3 meter connector cables.

**For USB 3.0 models:** 1 x USB 3.0 PCIe Card and 1 x 3 meter USB 3.0 cable (Type A to B)  
1 x Power supply with mains cable  
1 x 3-way Multi I/O timing cable, offering Fire, External Trigger and Arm (1.5 meter)  
1 x Quick Start Guide  
1 x CD containing Andor user guides  
1 x Individual system performance sheet

#### FOOTNOTES:

- Specifications are subject to change without notice
- Figures are typical unless otherwise stated.
  - Readout noise is for the entire system and is taken as a median over the sensor area excluding any regions of blemishes. It is a combination of sensor readout noise and A/D noise.
  - Quantum efficiency of the sensor at 20°C as supplied by the manufacturer.
  - Dark current measurement is taken as a median over the sensor area excluding any regions of blemishes.
  - Linearity is measured from a plot of Signal vs. Exposure Time over the full dynamic range.
  - Software Exposure Events provide rapid software notification (SDK only) of the start and end of acquisition, useful for tight synchronization to moving peripheral devices e.g. Z-stage.
  - The maximum frames/s table for Zyla indicate the maximum speed at which the device can acquire images in a standard system at full frame and also a range of sub-array size, for both rolling and global shutter read modes (Zyla 5.5), 12-bit single amplifier (rates also apply to dual amplifier 16-bit for Zyla 4.2). Note that the write speed of the PC hard drive can impose a further restriction to achieving sustained kinetic series acquisition.
  - 'Global Clear' is an optional keep clean mechanism that can be implemented in rolling shutter mode, which purges charge from all rows of the sensor simultaneously, at the exposure start. The exposure end is still rolling shutter. It can be used alongside the Fire All output of the camera and a pulsed light source to simulate Global Exposure mechanism, albeit less efficiently than the true Global Shutter exposure mode of Zyla 5.5. Furthermore Global Clear differs from true Global Shutter in that it can only be used in 'non-overlap' readout mode, i.e. sequential exposure and readout phases rather than simultaneous.
  - Zyla USB 3.0 models should work with any modern USB 3.0 enabled PC/laptop (provided hard drives or RAM is sufficient to support data rates) as every USB 3.0 port should have its own host controller. Zyla USB 3.0 models also ship with a USB 3.0 PCIe card as a means to add a USB 3.0 port to an older PC, or as a diagnostic aid to interoperability issues or to ensure maximum speed.



#### MINIMUM COMPUTER REQUIREMENTS:

- 2.68 GHz Quad Core
- 4GB RAM (increase RAM if to be used for continuous data spooling)
- Hard Drive:  
Minimum 450 MB/s continuous write for USB 3.0 models  
Minimum 850 MB/s continuous write for Camera Link 10-tap models
- PCI Express x4 or greater for USB 3.0 models
- PCI Express x8 or greater for Camera Link 10-tap models
- Windows (7, 8, 8.1 or 10) or Linux
- \* See technical note entitled: 'PC Specifications for sCMOS'
- \*\* Note, Andor supply PC workstations for Zyla, see page 10.

#### Operating and Storage Conditions

- Operating Temperature:  
Zyla 5.5: 0°C to 30°C ambient  
Zyla 4.2: 0°C to 27°C ambient
- Relative Humidity: < 70% (non-condensing)
- Storage Temperature: -10°C to 50°C

#### Power Requirements

- Please refer to page 11



Windows is a registered trademark of Microsoft Corporation